

Mobrey Magnetic Vertical Level Switches

For Critical Area Applications or General Purpose Control



- Rugged, robust, and trusted all over the world
- Ideal for tough process control duties
- Operates in almost any liquid at high pressures and temperatures
- Multiple switch points
- Unique three-magnet, snap action, and latching switch mechanism
- Unique hermetically-sealed switching mechanism option
- Unique treble-seal pressure tube and union
- Wide range of mounting options
- External chamber options

Overview of Mobrey Vertical Level Switches



Mobrey side-and-side chamber with a float level switch fitted



Direct mounted level switch with 3-in. float

Introduction

Whether you require a switch for critical area applications or just general purpose control, the extensive range of Mobrey switches ensures that we will always have a solution to your particular problem.

A choice of displacer-type or float-type operated level switch is available to order for direct vertical mounting (no chamber included). See [Table 1 on page 4](#) or [Table 2 on page 6](#) for ordering information.

These level switches can be optionally supplied mounted vertically in chambers, in a sealed or removable form. A range of carbon steel chambers are available, and for more vigorous applications there are stainless steel chambers. See [Table 3 on page 8](#) for ordering information.

There are a variety of instrument and process connection options available to make installation simple and economic. This gives you the choice to meet your application in keeping with your budget.

Quality and reliability

Mobrey vertical magnetic level switches for industrial and process control use have been available for over 20 years and have gained a reputation for quality and reliability.

Choice of switching mechanisms

There are two switching functions available: 2 x SPST (SPCO) or DPDT (DPCO) switching, and each comes in four variants:

- **General purpose** with silver cadmium oxide contacts for long life
- **Low power circuit** with gold-plated contacts for use in low current and voltage applications such as Intrinsically Safe (IS) circuits
- **High power circuits** giving up to 10 Amps switching capability
- **Hermetically-sealed** for the ultimate in reliability – *sealed for life*

Based on the industry-standard boiler water level controls, these controls use the same three-magnet switch mechanism for snap-action latching and switching. The design of this unique switch mechanism overcomes all the inherent problems of mercury tubes and micro switches. Even under severe vibration conditions, there are no springs to cause contact bounce, hover, or even failure. The snap-action magnets give a positive and stable latching, time after time after time.

Operation in extreme conditions

When controls are required to operate in extreme conditions, the unique Mobrey hermetically-sealed switch provides dependable life-long operation that you can rely on. With all its moving parts and contacts completely enclosed, this genuine hermetically-sealed switch is suitable for use in corrosive atmospheres and low temperature environments.

Contents

Overview of Mobrey Vertical Level Switches page 2
 Ordering Information page 4

Technical Specifications page 10
 Dimensional Drawings page 16

Features

- Unique switching mechanism – *totally reliable*
- No springs in switch mechanism – *positive snap action switching*
- Vibration resistant – *eliminates spurious trips*
- Multiple switch point options – *cost effective control*
- Genuine hermetically-sealed switch option – *totally safe and secure*
- Extensive range of chambers – *suitable for most applications*
- Relevant chambers are supplied CE marked and fully compliant with the Pressure Equipment Directive (97/23/EC)
- Designed to ASME B31.3
- Weld procedures approved to EN ISO 15614-1 and ASME IX
- Welders approved to EN 287-1
- Material certification to EN 10204, 3.1
- Materials to ASTM and British Standards (BS)

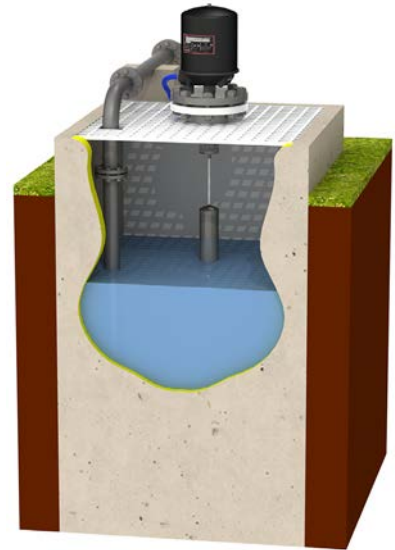

Sump application with direct mounted displacer-type level switch

Approvals

- CSA approval:
Explosion-proof for Class 1, Div 1, Groups B, C, and D
- Factory Mutual (FM) approval:
Explosion-proof for Class I, Div 1, Groups B, C, and D
Class II, Div 1, Groups E, F, and G
General Area, Weatherproof type NEMA 4
- Flameproof ATEX II 1/2G Ex d IIC T6 Ga/Gb (-50 °C ≤ Ta ≤ 60 °C)
- Flameproof IECEx Ex d IIC T6 Ga/Gb (-50 °C ≤ Ta ≤ 60 °C)
- Technical Regulation Customs Union (EAC) Flameproof 1Exd IIC T6X
(see certificate RU C-GB.1B06.B.00078 for Ta range) and Ordinary Location Mark

Intrinsically Safe Use

For intrinsically safe circuits, gold-plated switch contacts are recommended. Users are reminded that it is their responsibility to obtain the necessary system approval and licences for such circuits.

BS EN ISO 9001: 2008

Rosemount Measurement has been assessed and approved by Lloyds Register Quality Assurance against BS EN ISO 9001: 2008 for the design, development, assembly and re-calibration of precision instruments and systems for the measurement and indication of electrical signals, gas and liquid density, viscosity, pressure, level, flow and water/steam systems.

Quality assurance

With over 20 years worldwide experience in the major power, nuclear and petro-chemical industries, we are able to accommodate testing, surveying and documentation requirements as specified at the time of order. Inspection by customers or nominated inspection agencies can be arranged.



Direct mounted level switch with displacer type 11D

Ordering Information

Specification and selection of product materials, options, or components must be made by the purchaser of the equipment.

See [page 10](#) for more information on Material Selection.

Ordering information: direct mounting vertical displacer-type level switch [page 4](#)

Ordering information: direct mounting vertical float-type level switch [page 6](#)

Ordering information: chamber with mounted vertical float-type level switch [page 8](#)

Table 1. Ordering information: direct mounting vertical displacer-type level switch

★The Standard offering represents the most common options. The starred options (★) should be selected for best delivery.
The Expanded offering is subject to additional delivery lead time

Product Description			
D ⁽¹⁾	Direct mounting vertical level control (no chamber)		
Mounting Flange Material			Temperature Range
Standard			
C	Carbon steel		-10 to +300 °C ★
S	316L stainless steel		-50 to +300 °C ★
Function and Specification ⁽²⁾		Maximum Pressure at 20 °C	Temperature Range
Standard			
11D ⁽³⁾	Displacer, 3-in. NB, one switch, narrow differential	102 bar	-50 to +300 °C (See also Switch Mechanism Type for further limits)
12D ⁽³⁾	Displacer, 3-in. NB, one switch, wide differential		
13D ⁽³⁾	Displacer, 3-in. NB, two switches, two wide differentials		
18D ⁽³⁾	Displacer, 3-in. NB, two switches, two narrow differentials		
Expanded			
20D ⁽⁴⁾	Floating roof detection		
21D ⁽⁴⁾	Floating roof and overflow detection		
Switch Enclosure ⁽⁵⁾			
Standard			
S	150 mm (can fit one or two switch mechanisms)		★
Product Certifications			Enclosure Material
Standard			
E5	FM explosion-proof		A or I ★
E6	CSA explosion-proof		A or I ★
EM ⁽⁶⁾	Technical Regulation Customs Union (EAC) Flameproof		⁽⁶⁾ ★
G5	FM ordinary location (unclassified, safe area)		N ★
G6	CSA ordinary location (unclassified, safe area)		N ★
GM ⁽⁶⁾	Technical Regulation Customs Union (EAC) Ordinary Locations Mark		⁽⁶⁾ ★
KN	ATEX / IECEx flameproof		A or I ★
NA	No hazardous location certificates		N ★
Switch Enclosure Housing Material			
Standard			
N	Aluminium alloy base, drawn steel cover		★
A	Aluminium alloy		★
I	Cast iron		★
Conduit Entry			
Standard			
A	1-in NPT		★
B	20 mm thread		★

Table 1. Ordering information: direct mounting vertical displacer-type level switch

★The Standard offering represents the most common options. The starred options (★) should be selected for best delivery.
The Expanded offering is subject to additional delivery lead time

Number of Switch Mechanisms			
Standard			Standard
1	One switch		★
2	Two switches		★
Switch Mechanism Type ⁽⁷⁾			Maximum Wetside Temperature ⁽⁸⁾
Standard			Standard
D4	4 Contact: 2 × SPST (SPCO), general purpose		300 °C
P4	4 Contact: 2 × SPST (SPCO), low power circuits		
X4	4 Contact: 2 × SPST (SPCO), high power circuits		250 °C
H4	4 Contact: 2 × SPST (SPCO), hermetically sealed		
D8	8 Contact: DPDT (DPCO), general purpose		300 °C
P8	8 Contact: DPDT (DPCO), low power circuits		
X8	8 Contact: DPDT (DPCO), high power circuits		250 °C
H8	8 Contact: DPDT (DPCO), hermetically sealed		
Process Connection Size ⁽⁹⁾			
Standard			Standard
1	1 in. / 25 mm		★
3	3 in. / 80 mm		★
4	4 in. / 100 mm		★
Process Connection Rating ⁽⁹⁾			Connection Size
Standard			Standard
AA	ASME B16.5 Class 150		3 or 4
AB	ASME B16.5 Class 300		3 or 4
AC	ASME B16.5 Class 600		3 or 4
NN	NPT thread, 316 stainless steel		1
Process Connection Type			Connection Rating
Standard			Standard
R	Raised Face (RF) flange		AA, AB, or AC
N	NPT thread, 316 stainless steel		NN
Typical Model Number: D C 13D S NA N A 2 D4 3 AA R			

- (1) Supplied with 3 m of 316 stainless steel displacer cable as standard. Other lengths are available on request.
- (2) The switching-point is adjusted by moving the displacer elements on the cable. See “Displacer-type dimensions” on page 16 for information about this.
- (3) For minimum specific gravity requirements, see the section “Displacer-type dimensions” on page 16.
- (4) This switch is designed specifically for use on floating roof tanks to signal an alarm if the roof rises too high. See Product Data Sheet IP107/FR for full details.
- (5) See “Mobrey switch enclosures” on page 13 for information about these options.
- (6) Contact an Emerson Process Management representative for additional information.
- (7) See “Mobrey switch mechanisms and ratings” on page 12 for information about these options.
- (8) The maximum wetside temperatures shown here override the maximum wetside temperatures shown in Table 6 on page 12.
- (9) Other flange sizes and ratings are available on request.

Table 2. Ordering information: direct mounting vertical float-type level switch

★The Standard offering represents the most common options. The starred options (★) should be selected for best delivery.
 The Expanded offering is subject to additional delivery lead time

Product Description						
D ⁽¹⁾	Direct mounting vertical level control (no chamber)					
Mounting Flange Material					Temperature Range	
Standard					Standard	
C	Carbon steel				-10 to +400 °C	★
S	316L stainless steel				-101 to +400 °C	★
Function and Specification				Pressure Rating (in Bar)		
				20 °C	250 °C	
Standard					Standard	
11F ⁽²⁾	Float, 3-in. NB, minimum SG 0.80	34.5	22.5	20.2	★	
12F ⁽³⁾	Float, 4-in. NB, minimum SG 0.75	102.1	66.5	59.2	★	
13F ⁽³⁾	Float, 4-in. NB, minimum SG 0.65	51.1	33.2	29.6	★	
14F ⁽³⁾	Float, 4-in. NB, minimum SG 0.54	19.6	12.7	11.3	★	
17D ⁽⁴⁾	Float, spring-assisted, 4-in. NB, minimum SG 0.4	102.1	66.5	59.2	★	
Switch Enclosure ⁽⁵⁾				Product Certifications		
Standard					Standard	
R	62 mm (can fit a single switch mechanism)				All	★
S	150 mm (can fit up to four switch mechanisms)				All	★
L	250 mm (can fit up to six switch mechanisms)				G5 or NA	★
Product Certifications				Enclosure Material		
Standard					Standard	
E5	FM explosion-proof				A or I	★
E6	CSA explosion-proof				A or I	★
EM ⁽⁶⁾	Technical Regulation Customs Union (EAC) Flameproof				(6)	★
G5	FM ordinary location (unclassified safe area)				N	★
G6	CSA ordinary location (unclassified safe area)				N	★
GM ⁽⁶⁾	Technical Regulation Customs Union (EAC) Ordinary Locations Mark				(6)	★
KN	ATEX / IECEx flameproof				A or I	★
NA	No hazardous location certificates				N	★
Switch Enclosure Housing Material						
Standard					Standard	
N	Aluminium alloy base, drawn steel cover					★
A	Aluminium alloy					★
I	Cast iron					★
Conduit Entry						
Standard					Standard	
A	1-in NPT					★
B	20 mm thread					★
Number of Switch Mechanisms						
Standard					Standard	
1	One switch					★
2	Two switches					★
3	Three switches					★
4	Four switches					★
5	Five switches					★
6	Six switches					★

Table 2. Ordering information: direct mounting vertical float-type level switch

★The Standard offering represents the most common options. The starred options (★) should be selected for best delivery.
The Expanded offering is subject to additional delivery lead time

Switch Mechanism Type ⁽⁷⁾		Maximum Wetside Temperature	
Standard			Standard
D4	4 Contact: 2 × SPST (SPCO), general purpose	400 °C	★
P4	4 Contact: 2 × SPST (SPCO), low power circuits		★
X4	4 Contact: 2 × SPST (SPCO), high power circuits	250 °C	★
H4	4 Contact: 2 × SPST (SPCO), hermetically sealed		★
D8	8 Contact: DPDT (DPCO), general purpose	400 °C	★
P8	8 Contact: DPDT (DPCO), low power circuits		★
X8	8 Contact: DPDT (DPCO), high power circuits	250 °C	★
H8	8 Contact: DPDT (DPCO), hermetically sealed		★
Process Connection Size ⁽⁸⁾			
Standard			Standard
1	1 in. / 25 mm		★
3	3 in. / 80 mm		★
4	4 in. / 100 mm		★
Process Connection Rating ⁽⁸⁾		Connection Size	
Standard			Standard
AA	ASME B16.5 Class 150	3 or 4	★
AB	ASME B16.5 Class 300	3 or 4	★
AC	ASME B16.5 Class 600	3 or 4	★
NN	NPT thread, 316 stainless steel	1	★
Process Connection Type		Connection Rating	
Standard			Standard
R	Raised Face (RF) flange	AA, AB, or AC	★
N	NPT thread, 316 stainless steel	NN	★
Typical Model Number: D C 14 F S N A N A 1 D 4 4 A A R			

- (1) See "Float-type level switches" on page 10 for information about how the float-type level switches (**F) operate.
- (2) Mounting flange 3-in NB (Nominal Bore) or larger.
- (3) Mounting flange 4-in NB (Nominal Bore) minimum.
- (4) This float option is available when selecting Switch Enclosure code S and a single switching mechanism.
- (5) See "Mobrey switch enclosures" on page 13 for information about these options.
- (6) Contact an Emerson Process Management representative for additional information.
- (7) See "Mobrey switch mechanisms and ratings" on page 12 for information about these options.
- (8) Other flange sizes and ratings are available on request.

Table 3. Ordering information: chamber with mounted vertical float-type level switch

★The Standard offering represents the most common options. The starred options (★) should be selected for best delivery.
 The Expanded offering is subject to additional delivery lead time

Product Description				
B	Chamber mount vertical control. Bottle style			
X	Chamber mount vertical control. Flanged style			
Mounting Flange Material			Temperature Range	
Standard				
C	Carbon steel		-10 to +400 °C ★	
S	316L stainless steel		-101 to +400 °C ★	
Function and Specification ⁽¹⁾		Chamber Body Size	Maximum Pressure	
Standard				
11F	Float, 3-in. NB, minimum SG 0.80	3-in. NB or larger	See Table 4 or Table 5 on page 9 for the maximum ratings when mounted in the B* or X* chamber	
12F	Float, 4-in. NB, minimum SG 0.75	4-in. NB minimum		
13F	Float, 4-in. NB, minimum SG 0.65			
14F	Float, 4-in. NB, minimum SG 0.54			
17D ⁽²⁾	Float, spring-assisted, 4-in. NB, minimum SG 0.4			
Switch Enclosure ⁽³⁾				
Standard				
R	62 mm (can fit a single switch mechanism)			★
S	150 mm (can fit up to four switch mechanisms)			★
Product Certifications			Enclosure Material	
Standard				
E5	FM explosion-proof		A or I ★	
E6	CSA explosion-proof		A or I ★	
EM ⁽⁴⁾	Technical Regulation Customs Union (EAC) Flameproof		(4) ★	
G5	FM ordinary location (unclassified, safe area)		N ★	
G6	CSA ordinary location (unclassified, safe area)		N ★	
GM ⁽⁴⁾	Technical Regulation Customs Union (EAC) Ordinary Locations Mark		(4) ★	
KN	ATEX / IECEx flameproof		A or I ★	
NA	No hazardous location certificates		N ★	
Switch Enclosure Housing Material				
Standard				
N	Aluminium alloy base, drawn steel cover			★
A	Aluminium alloy			★
I	Cast iron			★
Conduit Entry				
Standard				
A	1-in NPT			★
B	20 mm thread			★
Number of Switch Mechanisms				
Standard				
1	One switch			★
2	Two switches			★
3	Three switches			★
4	Four switches			★
Switch Mechanism Type ⁽⁵⁾		Maximum Wetside Temperature ⁽⁶⁾		Standard
		Carbon St. Chamber	Stainless St. Chamber	
Standard				
D4	4 Contact: 2 × SPST (SPCO), general purpose		400 °C	300 °C ★
P4	4 Contact: 2 × SPST (SPCO), low power circuits			★
X4	4 Contact: 2 × SPST (SPCO), high power circuits		250 °C	★
H4	4 Contact: 2 × SPST (SPCO), hermetically sealed			250 °C
D8	8 Contact: DPDT (DPCO), general purpose		400 °C	★
P8	8 Contact: DPDT (DPCO), low power circuits			300 °C

Table 3. Ordering information: chamber with mounted vertical float-type level switch

★The Standard offering represents the most common options. The starred options (★) should be selected for best delivery. The Expanded offering is subject to additional delivery lead time

X8	8 Contact: DPDT (DPCO), high power circuits	250 °C	250 °C	★
H8	8 Contact: DPDT (DPCO), hermetically sealed			★
Instrument Connection Type				
Standard				Standard
R	Raised Face (RF) flange			★
N	NPT thread, 316 stainless steel, for use with bottle style chambers			★
Process Connection Orientation				
Standard				Standard
B	Side and side with 1-in. NPT drain			★
C	Side and bottom			★
Process Connection Size (7)				
Standard				Standard
1	1 in. / 25 mm (DN25)			★
5	1.5 in. / 40 mm (DN40)			★
2	2 in. / 50 mm (DN50)			★
Process Connection Rating (7)			Connection Size	
Standard				Standard
AA	ASME B16.5 Class 150		1, 5, or 2	★
AB	ASME B16.5 Class 300		1, 5, or 2	★
AC	ASME B16.5 Class 600		1, 5, or 2	★
NN	NPT thread, 316 stainless steel		1	★
Process Connection Type			Connection Rating	
Standard				Standard
R	Raised Face (RF) flange		AA, AB, or AC	★
N	NPT thread, 316 stainless steel		NN	★
Typical Model Number: X C 12F S KN A B 1 X4 R B 1 AA R				

- (1) The float switch choice here also determines if a 3-in. or 4-in. chamber is supplied.
- (2) This float option is available when selecting Switch Enclosure code S and a single switching mechanism.
- (3) See “Mobrey switch enclosures” on page 13 for information about these options.
- (4) Contact an Emerson Process Management representative for additional information.
- (5) See “Mobrey switch mechanisms and ratings” on page 12 for information about these options.
- (6) The maximum wet-side temperatures shown here override the maximum wet-side temperatures shown in Table 6 on page 12.
- (7) Other flange sizes and ratings are available on request.

Table 4. Type 11F, 12F, 13F, 14F and 17D maximum pressure ratings (when mounted in a carbon steel chamber)

Float Type	Flanged Style Chambers (XC) Maximum Pressure Rating in Bar			Flanged Process Connections Maximum Pressure Rating in Bar			Threaded/Socket Process Connections Maximum Pressure Rating in Bar		
	20 °C	250 °C	400 °C	20 °C	250 °C	400 °C	20 °C	250 °C	400 °C
11F	34.5	22.5	20.0	30.1	22.5	20.0	30.1	22.5	20.0
12F	102.1	66.3	59.2	88.8	66.3	59.2	88.8	66.3	59.2
13F	51.1	33.2	29.6	44.6	33.2	29.6	44.6	33.2	29.6
14F	19.6	12.1	6.5	17.1	12.7	6.5	17.1	12.7	6.5
17D	102.1	66.3	59.2	88.8	66.3	59.2	88.8	66.3	59.2

Table 5. Type 12F, 13F, 14F and 17D maximum pressure ratings (when mounted in a stainless steel chamber)

Float Type	Flanged Style Chambers (XS)			Flanged Process Connections			Threaded/Socket Process Connections		
	20 °C	250 °C	400 °C	20 °C	250 °C	400 °C	20 °C	250 °C	400 °C
12F	82.7	54.9	48.6	82.7	54.9	48.6	88.8	66.3	59.2
13F	41.4	27.5	24.3	41.4	27.5	24.3	44.6	33.2	29.6
14F	15.9	10.5	6.5	15.9	10.5	6.5	17.1	12.7	11.3
17D	82.7	54.9	48.6	82.7	54.9	48.6	88.8	66.3	59.2

Technical Specifications

Material selection

Emerson provides a variety of Mobrey products with various product options and configurations including materials of construction that can be expected to perform well in a wide range of applications. The Mobrey product information presented is intended as a guide for the purchaser to make an appropriate selection for the application. It is the purchaser's sole responsibility to make a careful analysis of all process parameters (such as all chemical components, temperature, pressure, flow rate, abrasives, contaminants, etc.), when specifying product, materials, options and components for the particular application. Emerson Process Management is not in a position to evaluate or guarantee the compatibility of the process fluid or other process parameters with the product, options, configuration or materials of construction selected.

Float-type level switches

A vertical float-type level switch is usually mounted vertically on the top of a process vessel (tank) or in an external chamber (Figure 1), and relies upon the liquid lifting the float (using buoyancy principles) until it reaches a level that switches the output.

Figure 1.
Cut-away illustration showing a Mobrey vertical float-type level switch sealed in a Mobrey chamber

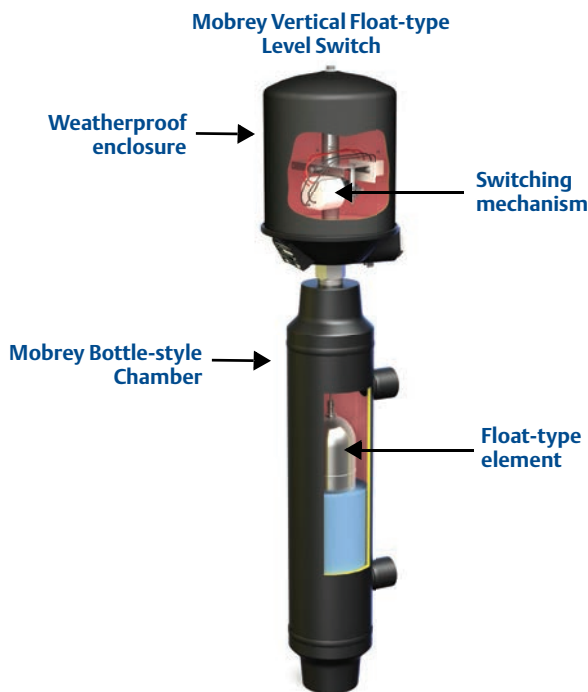

One or more switching mechanisms (see page 12) are mounted inside a weatherproof or flameproof enclosure. Switching is achieved with the unique Mobrey three-magnet system, giving reliable snap-action 'latch-on' switching.

The float element (Figure 2) carries a permanent magnet as part of the float and rod assembly which rises and falls vertically as a liquid level changes.

The vertical movement of the *first* permanent magnet interacts with a *second* permanent magnet that is inside the switching mechanism. This interaction simultaneously actuates a *third* permanent magnet (also in the switching mechanism) to actuate the contacts and indicate a switched output change.

The float magnet can continue upwards and actuate switch mechanisms at other level points. Switch mechanisms that are already actuated are not re-set until the float magnet returns and falls below the switch mechanism.

These electro-mechanical switches are not complicated and give a reliable switching output in high or low level alarm applications.

Where switching points are required a long distance below the mounting point of the vertical level switch, a displacer-type element (see page 11) can be used instead of a float-type element.

Figure 2. Float element types

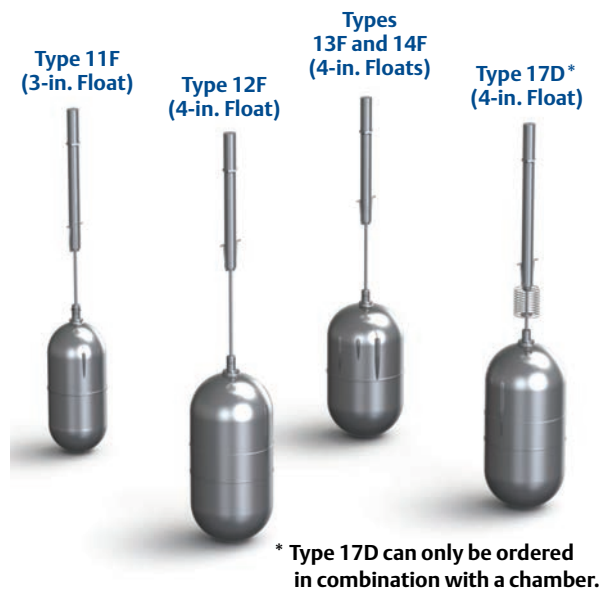

Note: See "Dimensional Drawings" on page 16 for more data.

Direct mount displacer controls

Mobrey displacer-operated controls are ideal for sump applications and other top-mounting duties such as a low level alarm warning in deep tanks.

The operation principles also make them suitable, in a modified form, for very high pressure or low specific gravity applications.

The four most popular displacer arrangements are shown in Figure 3, which covers most of the likely applications. However, if you have a different requirement, we would be pleased to quote a model for your particular application.

Figure 3. Popular displacer arrangements

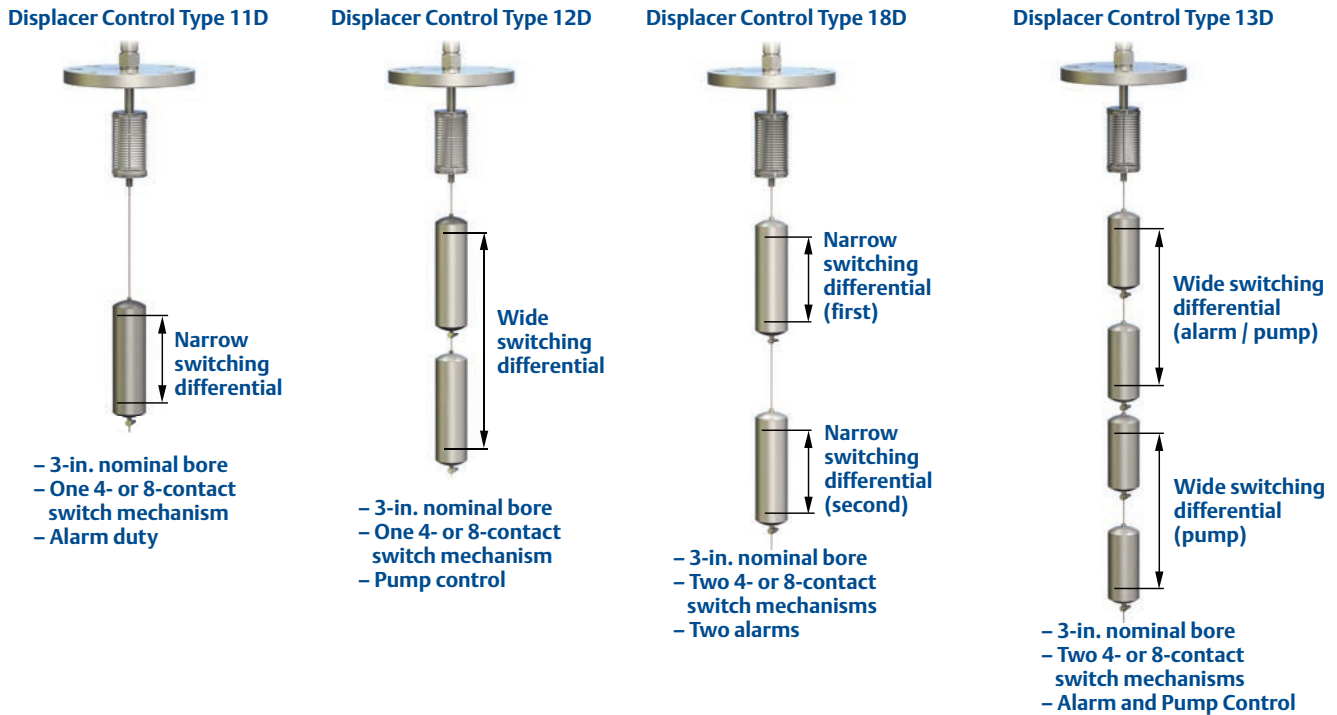

Operation principles

The displacer element, made of 316 stainless steel, is suspended on a stainless steel cable from a Nimonic 90 spring. The element is always heavier than its equivalent volume of the liquid in which it is to operate, and so will extend the tension spring at all times. In free air, the spring will be extended to a known length, controlled by a mechanical stop to prevent overstressing. Fixed to the spring is the rod and magnet assembly, free to move up and down as the spring extends or contracts.

As liquid rises to cover the displacer element, a buoyancy force is created equal to the weight of the liquid displaced. This force, in effect, is seen by the spring as a reduction in weight, causing the spring to contract. The spring contraction moves the magnet upwards and actuates the switch mechanism.

On a falling liquid level, the displacer element is uncovered and the spring sees an increasing effective weight, causing the spring to extend and move the magnet downwards to re-set the switch mechanism.

This simple principle can be refined to operate a single switch over a very wide differential (12D arrangement) by providing the buoyancy force from two elements instead of just one.

Two-switch-mechanism models are available for either two-alarms duty with two narrow differentials (18D arrangement) or for pump control/alarm duty with appropriate differentials (13D arrangement).

In all cases, because the elements are suspended on a cable, switching or control levels can be several metres below the mounting flange, and are fully field adjustable by re-setting the elements on the cable. The standard cable length is 3 m but can be cut to a shorter length (see "Dimensional Drawings" on page 16 for minimum lengths).

Mobrey switch mechanisms and ratings

Each Mobrey switch mechanism has flying leads which are factory-wired to the ceramic terminal blocks (in the enclosure) for **SPST (SPCO) relay** operation, as shown in Figure 4. For **DPDT (DPCO) relay** operation, the installer must common any one pair of A and B wires in the terminal block for each of the two sets of mechanisms.

Table 6. Mobrey switch mechanisms

Type	Purpose ⁽¹⁾
D4 or D8	General purpose switch mechanism.
X4 or X8	High current switch mechanism.
P4 or P8	Switch mechanism with gold-plated contacts for use in low-power or intrinsically safe circuits.
H4 or H8	Hermetically-sealed mechanism with gold-plated contacts. All moving parts and contacts are enclosed in an inert gas-filled stainless steel enclosure. Suitable for use in low temperatures, contaminated atmospheres, and intrinsically safe circuits.

(1) Switches must not be used for the direct starting of motors.

Figure 4. Mobrey switch mechanisms

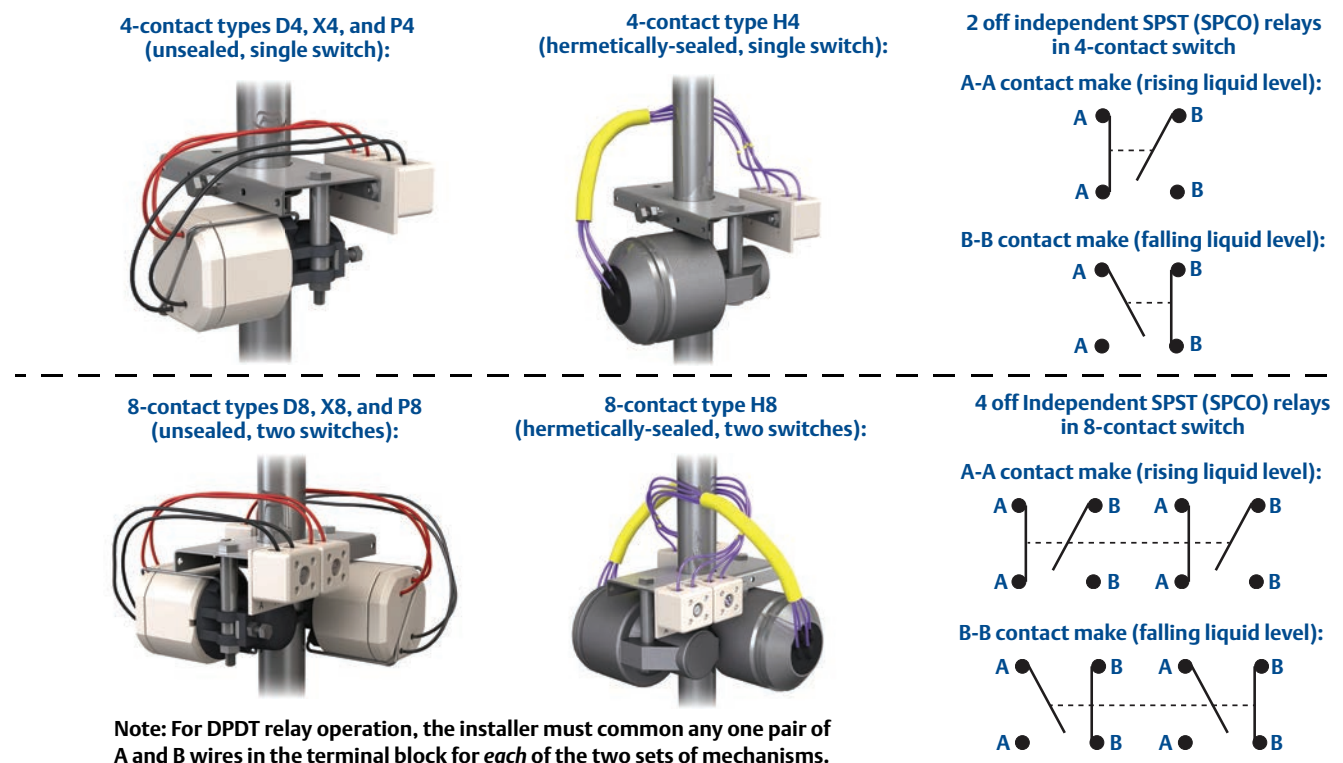

Note: For DPDT relay operation, the installer must common any one pair of A and B wires in the terminal block for each of the two sets of mechanisms.

Table 7. Electrical ratings for Mobrey switch mechanisms

Type	Maximum wetside temperature ⁽¹⁾	Low temperature use	AC maximum values			DC maximum values			
			VA	Volts	Amps	Watts	Volts	Residual amps	Inductive amps
D4 or D8	400 °C	No	2000	440	5	50	250	5	0.5
X4 or X8	250 °C	No	2000	440	10	50	250	10	0.5
P4 or P8 ⁽²⁾	400 °C	No	6	250	0.25	3.6	250	0.25	0.1
H4 or H8 ⁽³⁾	250 °C	-50 °C	2000	440	5	50	250	5	0.5

(1) See also ordering information tables on pages 4, 6, and 8 for further operating temperature limits.

(2) The gold plating on the contacts of P4 and P8 switch mechanisms may be permanently damaged if the mechanisms are used to switch circuits with values greater than those shown above.

(3) The gold plating on the contacts of H4 and H8 switch mechanisms may be permanently damaged if the mechanisms are used to switch circuits with values greater than those shown for P4 and P8 above.

Mobrey switch enclosures

Figure 5. Mobrey switch enclosures

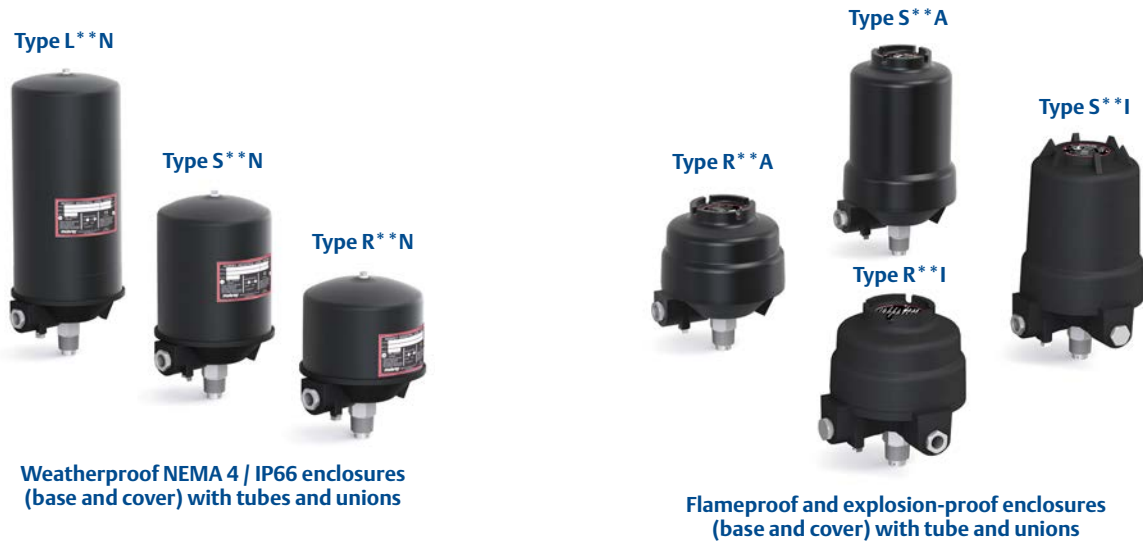

Weatherproof NEMA 4 / IP66 enclosures

- Aluminium alloy base and drawn steel cover (code “N”)
- Type R**N: Fixed switch
- Type S**N: up to 94 mm switch point adjustment
- Type L**N: up to 194 mm switch point adjustment

Flameproof and explosion-proof enclosures

- Aluminium alloy base and cover (code “A”)
- Cast iron base and cover (code “I”)
- Type R**A or R**I: Fixed switch
- Type S**A or S**I: up to 94 mm switch point adjustment
- These enclosures also have a weatherproof rating to NEMA 4 / IP66

Conduit entries

- Enclosures supplied with 4-contact switch mechanisms have a single 1-in. NPT conduit entry
- Enclosures supplied with 8-contact switch mechanisms have two 1-in. NPT conduit entries.
- Weatherproof NEMA 4 / IP66 enclosures with 8-contact switches are supplied with a cast iron base instead of the aluminium alloy base, and have two 1-in. conduit entries.

Tube and unions

- 316 stainless steel throughout
- Welded construction with additional swaging technique to ensure maximum integrity
- Individually pressure tested to 150 bar (operating pressure is limited by the float or flange specified)

Paint Finish:

- Black stove paint
- Epoxy paint finishes available on request

Mobrey vertical chambers

The Mobrey vertical chamber range is the result of many years of experience in designing and manufacturing chambers in accordance with international codes.

The self-contained chamber is for externally mounting the Mobrey range of vertical level switches to a vessel. Externally mounting the level switch in a chamber means it can be isolated for routine maintenance while keeping the plant operational. It is also useful for in-tank restrictions that do not allow mounting of the level switch in a vessel

Table 8. Chamber types and construction materials

Bottle construction	Flanged construction
<ul style="list-style-type: none"> ■ Stainless steel option: code BS ■ Carbon steel option: code BC ■ Float is sealed inside chamber during manufacture ■ Side-and-bottom or Side-and-side process connection orientations (see Table 9) 	<ul style="list-style-type: none"> ■ Stainless steel option: code XS ■ Carbon steel option: code XC ■ Float may be removed from chamber for maintenance or inspection ■ Side-and-bottom or Side-and-side process connection orientations (see Table 9) 

Table 9. Process connection orientation

Style 1: Side-and-bottom (Process Connection Orientation code C)	Style 2: Side-and-side with 1-in. NPT drain (Process Connection Orientation code B)
	
<ul style="list-style-type: none"> ■ See page 18 for chamber dimensions, operating levels, and technical data. 	

Quality standards

Mobrey Vertical Level Controls are manufactured to the highest standards of quality with only certified materials: BS EN 10204: 2004-3.1. Design of Mobrey chambers is in accordance with ASME B31.3. Relevant chambers are supplied CE marked and fully compliant with the Pressure Equipment Directive (97/23/EC).

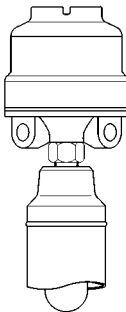
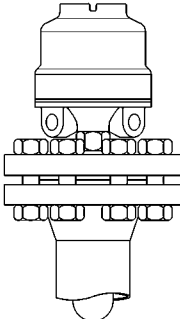
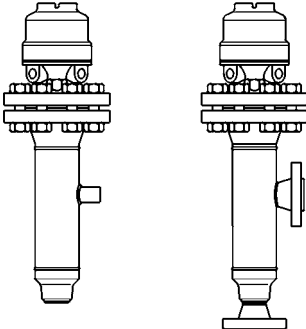
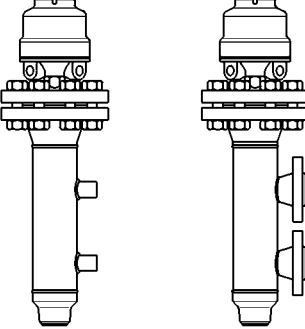
Weld procedures approved to EN ISO 15614-1 and ASME IX, welders approved to BS EN 287-1. Circumferential and set-on branch welds are full penetration welds, with visual inspection in accordance with ASME B31.3 “normal service” requirements and our company standard 417.

All pressure retaining assemblies are hydrostatically pressure tested to a minimum of 1.43 × maximum working pressure or to flange standard requirements.

Radiography or other NDT techniques can be accommodated provided that they are specified at time of order entry.

Inspection

Whilst Rosemount Measurement employ inspectors in house, unconnected with production, customers frequently ask for outside inspection. We are happy to accommodate nominated inspectors if agreed at order entry.

Some specifications require a quality control plan detailing inspection points and hold points. Rosemount Measurement will produce these QC plans for customer approval if agreed at order entry.

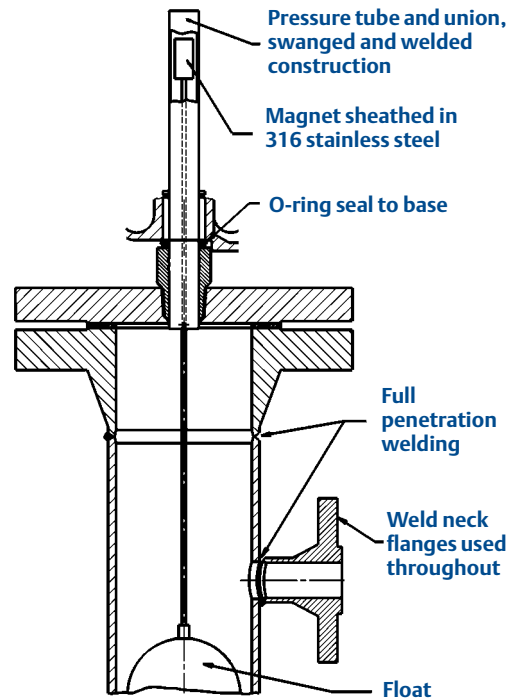

Table 10. Pressure ratings (bar)

Material	Carbon steel: A105			Stainless steel: 316L		
	20 °C	250 °C	400 °C	20 °C	250 °C	400 °C
ASME B16.5 Class 150	19.6	12.1	6.5	15.9	10.5	6.5
ASME B16.5 Class 300	51.1	41.9	34.7	41.4	27.5	24.3
ASME B16.5 Class 600	102.1	83.9	69.4	82.7	54.9	48.6

Table 11. Construction materials

	Carbon steel chamber	Stainless steel chamber
Chamber tube	ASTM A106 grade B	ASTM A312 TP316L
Top casting	ASTM A216	-
Top/bottom caps	ASTM A105	ASTM A182 F316L / A403 WP316L
Top cover	ASTM A105	ASTM A182 F316L
Flanges/fittings	ASTM A105	ASTM A182 F316
Studs	ASTM A193-B7	ASTM A320-L7
Nuts	ASTM A194-2H	ASTM A194 Grade 7+S3
Standard carbon steel chamber temperature range is -10 to +400 °C. Stainless steel chamber temperature range is -101 to +400 °C.		

Options

- Low temperature carbon steel
- Process connections to specification
- Duplex UNS31803
- Ratings up to ASME Class 2500
- Cr. mo. steels
- 3.1 identifiable certification
- N.A.C.E. requirements
- N.D.T. to your specifications
- Vent and drain connections

Dimensional Drawings

Displacer-type dimensions

Note that the minimum specific gravity requirement varies by displacer type and switching mechanism type. Dimension S is the adjustable distance for the upper switching point level. Dimension E is the switching differential.

Table 12. Displacer-type dimensions

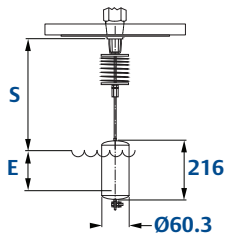

Type 11D (one 4- or 8-contact switch mechanism and narrow switching differential)

- Specify for alarm duty
- Switching point level can be changed by simply moving the displacer up or down the cable

	4-contact switches (D4, P4, X4, and H4)				8-contact switches (D8, P8, X8, H8)		
S.G.	0.6	0.75	1.0	1.2	0.75	1.0	1.2
S (minimum)	315 mm	335 mm	365 mm	380 mm	275 mm	320 mm	340 mm
E	90 mm	70 mm	60 mm	55 mm	135 mm	105 mm	90 mm

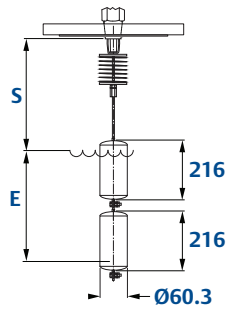

Type 12D (one 4- or 8-contact switch mechanism and wide switching differential)

- The two displacer elements are positioned at any point on the cable to correspond to the switching point level required. Should the liquid level drop to the **lower displacer element**, the switch mechanism is actuated and starts (or stops) a pump. When the liquid rises to the **upper displacer element**, the switch mechanism is again actuated to stop (or start) the pump.

	4-contact switches (D4, P4, X4, and H4)				8-contact switches (D8, P8, X8, H8)			
S.G.	0.5	0.8	1.0	1.2	0.75	0.8	1.0	1.2
S (minimum)	415 mm	430 mm	430 mm	425 mm	390 mm	390 mm	400 mm	400 mm
E	165 mm	110 mm	95 mm	80 mm	205 mm	200 mm	165 mm	140 mm

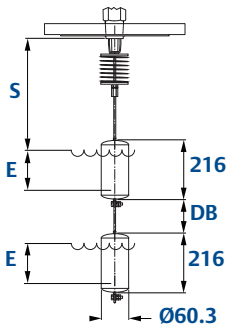

Type 18D (two 4- or 8-contact switch mechanisms and two narrow switching differentials)

- The two displacer elements are positioned **apart** to form two separate switching (alarm) point levels. This arrangement is typical for a sump application.

	4-contact switches (D4, P4, X4, and H4)				8-contact switches (D8, P8, X8, H8)		
S.G.	0.6	0.8	1.0	1.2	0.8	1.0	1.2
S (minimum)	390 mm	385 mm	375 mm	365 mm	355 mm	350 mm	345 mm
E	90 mm	70 mm	60 mm	55 mm	135 mm	105 mm	90 mm
Dead band	200 mm	230 mm	255 mm	310 mm	165 mm	215 mm	250 mm

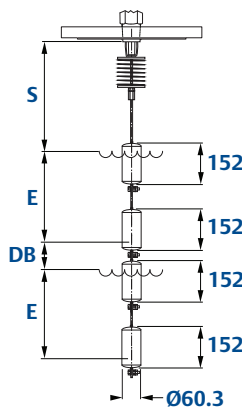

Type 13D (two 4- or 8-contact switch mechanisms and wide switching differential)

- A pump is controlled between the **middle** and the **lower** displacer elements positioned on the cable at the required levels. Should the level rise to the **upper** displacer element, this actuates the upper alarm switch which remains actuated until the level drops to the middle displacer element. Alternatively, the upper switch could control a second pump.

	4-contact switches (D4, P4, X4, and H4)				8-contact switches (D8, P8, X8, H8)		
S.G.	0.6	0.8	1.0	1.2	0.8	1.0	1.2
S minimum	390 mm	385 mm	375 mm	365 mm	355 mm	350 mm	345 mm
E	135 mm	110 mm	95 mm	80 mm	200 mm	145 mm	140 mm
Dead band	220 mm	255 mm	285 mm	310 mm	165 mm	215 mm	250 mm

Float-type dimensions

Table 13. Direct Mounting Float Type Dimensions

Float Type for 3-in. Nominal Bore Mounting: 11F				Floats Types for 4-in. Nominal Bore Mounting: 12F, 13F, 14F, and 17D				
<p>For enclosure dimensions, see Table 14 on page 17.</p>				<p>For enclosure dimensions, see Table 14 on page 17.</p>				
Switch Enclosure	11F			Maximum Wet Switching Differential	12F 13F 14F 17D			Maximum Wet Switching Differential
	Minimum H	Maximum H	Switch Adjustment		Minimum H	Maximum H	Switch Adjustment ⁽¹⁾	
R**NR**AR**I	155 mm	315 mm	None	20 mm (fixed)	155 mm	415 mm	None	20 mm (fixed)
S**NS**AS**I	155 mm	315 mm	Up to 94 mm	Up to 114 mm	155 mm	415 mm	Up to 94 mm	Up to 114 mm
L**N ⁽²⁾	-	-	-	-	155 mm	415 mm	Up to 194 mm	Up to 214 mm

- (1) For enclosures S** and L**, the switch mechanism mount position can be adjusted (vertically on the pressure tube) to change the switching point where the primary permanent magnet in the float and rod assembly actuates the switch.
- (2) The L**N enclosure is not available for the 11F, 17D, or any float level switches that are supplied with a chamber.

Dimensions of switch enclosures

Table 14. Dimensions of switch enclosures

Weatherproof enclosures R**N, S**N, L**N	Hazardous area enclosures R**A, R**I, S**A, S**I
<p>Enclosure cover</p> <p>Ø163</p> <p>Ø191</p> <p>2 off 1-in. NPT cable entries</p> <p>Pressure tube and union</p> <p>1-in. NPT thread</p> <p>Enclosure base</p> <p>R**N: 170 S**N: 275 L**N: 375 (Allow extra for cover removal)</p> <p>Dimensions for bases with a single 1-in. NPT cable entry are the same.</p>	<p>Enclosure cover</p> <p>Ø180</p> <p>2 off 1-in. NPT cable entries</p> <p>Pressure tube and union</p> <p>1-in. NPT thread</p> <p>Enclosure base</p> <p>R**A, R**I: 190 S**A, S**I: 300 (Allow extra for cover removal)</p> <p>Enclosure type S**I has a different cover look (Figure 5 on page 13) but the dimensions shown here are the same.</p> <p>Dimensions for bases with a single 1-in. NPT cable entry are the same.</p>

Chambers with vertical level switches fitted

Table 15. Chamber dimensional and operating level data

Style 1: Side-and-Bottom					Style 2: Side-and-Side					
<p>For enclosure dimensions, see Table 14 on page 17.</p>					<p>For enclosure dimensions, see Table 14 on page 17.</p>					
Process Connections	A		B ⁽¹⁾	C ⁽²⁾	D ⁽²⁾		E		F	
	'R' Enclosure	'S' Enclosure	Chamber Type BC/Others		Single Switch 'R' Enclosure	Multi Switch 'S' Enclosure	Single Switch 'R' Enclosure	Multi Switch 'S' Enclosure	Chamber Type BC/BS XC/XS	
1-in. NPT (side/bottom)	300	385	76/95	50	70	164	-	-	48/160	225
1-in. NPT (side/side)	-	-	95	50	70	164	271	356	160	225
1-in. 150	356	441	110	50	70	164	271	356	160	225
1-in. 300	356	441	117	50	70	164	271	356	160	225
1-in. 600	356	441	123	50	70	164	271	356	160	225
1½-in. 150	356	441	115	50	70	164	271	356	160	225
1½-in. 300	356	441	121	50	70	164	271	356	160	225
1½-in. 600	356	441	126	50	70	164	271	356	160	225
2-in. 150	356	441	112	50	70	164	271	356	160	225
2-in. 300	356	441	118	50	70	164	271	356	160	225
2-in. 600	356	441	129	50	70	164	271	356	160	225
Operating levels: Type 17D float in any chamber										
Operating S.G.	0.4	0.5	0.6	0.7	0.8	0.9	1.0	1.1	1.2	
Dimension C	65	73	82	91	100	109	118	127	136	
Dimension D	118	122	127	132	137	141	147	152	156	

Note: All dimensions are in mm. See Table 3 on page 8 for explanation of order codes R, S, BC, BS, XC, and XS.

- (1) The B dimension given is for a 4-in. Nominal Bore (NB) chamber (for 12F, 13F, 14F, and 17D floats). For a 3-in. NB chamber (11F float), subtract 13 mm.
- (2) D - C = Wet switching differential (maximum)

*The Emerson logo is a trademark and service mark of Emerson Electric Co.
Rosemount is a registered trademark of Rosemount Inc.
Mobrey is a registered trademark of Rosemount Measurement Ltd.
All other marks are the property of their respective owners.
Standard Terms and Conditions of Sale can be found at www.rosemount.com/terms_of_sale*

© 2015 Rosemount Measurement Limited. All rights reserved.

**Emerson Process Management
Rosemount Measurement Ltd.**
158 Edinbrough Avenue,
Slough, Berks., SL1 4UE, UK
Tel +44 (0)1753 756600
Fax +44 (0)1753 823589
www.mobrey.com

**Emerson Process Management
Rosemount Inc.**
8200 Market Boulevard
Chanhassen MN 55317 USA
Tel (USA) 1 800 999 9307
Tel (International) +1 952 906 8888
Fax +1 952 906 8889

mobrey

